

GRADO 80

ACCESORIOS

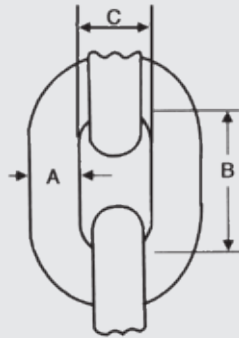

| CADENA ALTA RESISTENCIA DIN EN-818-2 G.80 | | | | | |
|---|-------------|----------------------------------|----|------|------------------|
| MEDIDA (MM.) | C.M.T. TON. | PRINCIPALES DIMENSIONES EN (MM.) | | | PESO NETO (KGS.) |
| | | A | B | C | |
| 6-8 | 1,12 | 6 | 18 | 8,50 | 0,80 |
| 8-8 | 2,00 | 8 | 24 | 11 | 1,40 |
| 10-8 | 3,15 | 10 | 30 | 14 | 2,20 |
| 13-8 | 5,30 | 13 | 39 | 18 | 3,70 |
| 16-8 | 8,00 | 16 | 48 | 22 | 5,70 |
| 20-8 | 12,50 | 20 | 57 | 26 | 7,80 |
| 22-8 | 15,00 | 22 | 66 | 30 | 10,90 |
| 26-8 | 21,20 | 26 | 78 | 35 | 15,20 |
| 32-8 | 31,50 | 32 | 96 | 43 | 23,00 |

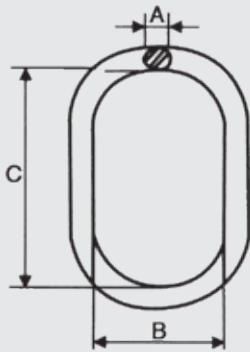

| ANILLA OVALADA G.80 | | | | | |
|---------------------|-------------|----------------------------------|-----|-----|------------------|
| MODELO | C.M.T. TON. | PRINCIPALES DIMENSIONES EN (MM.) | | | PESO NETO (KGS.) |
| | | A | B | C | |
| AN76 | 1,60 | 13 | 60 | 110 | 0,40 |
| AN87 | 2,12 | 16 | 60 | 110 | 0,55 |
| AN108 | 3,15 | 18 | 75 | 135 | 0,80 |
| AN1310 | 5,30 | 22 | 90 | 160 | 1,50 |
| AN1613 | 8,00 | 26 | 100 | 180 | 2,30 |
| AN1816 | 11,20 | 32 | 110 | 200 | 4,00 |
| AN2018 | 14,00 | 36 | 140 | 260 | 6,50 |
| AN2220 | 17,00 | 40 | 160 | 300 | 9,00 |
| AN2622 | 21,20 | 45 | 180 | 340 | 13,00 |
| AN3226 | 31,50 | 50 | 190 | 350 | 16,50 |
| AN3632 | 45,00 | 56 | 200 | 400 | 23,50 |

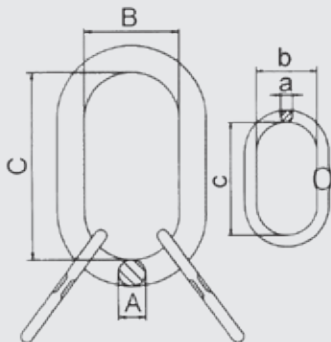

| ANILLA MAESTRA G.80 | | | | | | | | |
|---------------------|-------------|----------------------------------|-----|-----|----|-----|-----|------------------|
| MEDIDA (MM.) | C.M.T. TON. | PRINCIPALES DIMENSIONES EN (MM.) | | | | | | PESO NETO (KGS.) |
| | | A | B | C | A | B | C | |
| HA-06 | 2,36 | 18 | 77 | 133 | 14 | 26 | 56 | 1,30 |
| HA-08 | 4,25 | 22 | 89 | 156 | 16 | 33 | 72 | 2,20 |
| HA-10 | 6,70 | 25 | 99 | 180 | 18 | 41 | 87 | 3,20 |
| HA-13 | 11,20 | 31 | 111 | 196 | 22 | 52 | 115 | 6,00 |
| HA-16 | 17,00 | 36 | 131 | 261 | 25 | 65 | 140 | 9,50 |
| HA-20 | 26,50 | 50 | 191 | 353 | 32 | 89 | 185 | 23,50 |
| HA-22 | 31,50 | 51 | 191 | 354 | 37 | 106 | 180 | 25,40 |
| HA-26 | 45,00 | 57 | 210 | 410 | 40 | 105 | 183 | 35,50 |
| HA-32 | 74,80 | 70 | 252 | 420 | 50 | 116 | 200 | 59,60 |

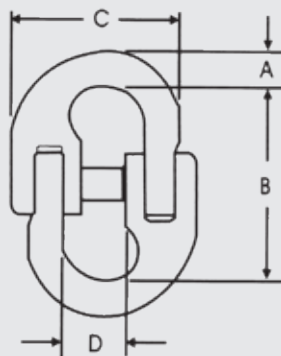

| CONECTOR G.80 | | | | | | |
|---------------|-------------|----------------------------------|-----|-----|----|------------------|
| MEDIDA (MM.) | C.M.T. TON. | PRINCIPALES DIMENSIONES EN (MM.) | | | | PESO NETO (KGS.) |
| | | A | B | C | D | |
| 6-8 | 1,12 | 8 | 42 | 37 | 16 | 0,14 |
| 8-8 | 2,00 | 9 | 59 | 48 | 21 | 0,21 |
| 10-8 | 3,15 | 13 | 70 | 60 | 28 | 0,40 |
| 13-8 | 5,30 | 15 | 87 | 76 | 30 | 0,60 |
| 16-8 | 8,00 | 20 | 106 | 92 | 37 | 1,20 |
| 20-8 | 12,50 | 24 | 117 | 106 | 45 | 1,80 |
| 22-8 | 15,00 | 27 | 138 | 130 | 51 | 2,80 |
| 26-8 | 21,20 | 32 | 156 | 154 | 59 | 4,40 |
| 32-8 | 31,50 | 38 | 197 | 187 | 68 | 8,30 |

CONECTOR POLIÉSTER G.80

| MEDIDA (MM.) | C.M.T. TON. | PRINCIPALES DIMENSIONES EN (MM.) | | | | | | PESO NETO (KGS.) |
|--------------|-------------|----------------------------------|-----|-----|----|----|----|------------------|
| | | A | B | C | D | E | F | |
| 6-8 | 1,12 | 16 | 60 | 55 | 35 | 18 | 8 | 0,20 |
| 8-8 | 2,00 | 20 | 62 | 64 | 37 | 23 | 9 | 0,30 |
| 10-8 | 3,15 | 26 | 66 | 80 | 37 | 30 | 13 | 0,50 |
| 13-8 | 5,30 | 30 | 87 | 94 | 51 | 36 | 16 | 1,10 |
| 16-8 | 8,00 | 36 | 107 | 120 | 64 | 45 | 22 | 2,00 |
| 20-8 | 12,50 | 44 | 127 | 134 | 78 | 50 | 23 | 2,90 |

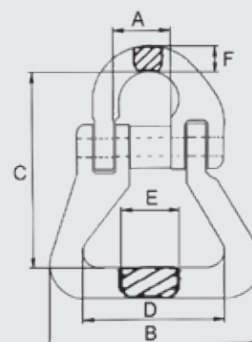

GANCHO CON PESTILLO G.80

| MEDIDA (MM.) | C.M.T. TON. | PRINCIPALES DIMENSIONES EN (MM.) | | | | | PESO NETO (KGS.) |
|--------------|-------------|----------------------------------|-----|-----|----|----|------------------|
| | | A | B | C | D | E | |
| 6-8 | 1,12 | 20 | 79 | 24 | 9 | 14 | 0,30 |
| 8-8 | 2,00 | 25 | 97 | 29 | 11 | 17 | 0,40 |
| 10-8 | 3,15 | 38 | 118 | 30 | 15 | 21 | 0,90 |
| 13-8 | 5,30 | 42 | 150 | 39 | 20 | 27 | 1,80 |
| 16-8 | 8,00 | 50 | 183 | 47 | 23 | 35 | 2,90 |
| 20-8 | 12,50 | 62 | 222 | 51 | 27 | 48 | 6,40 |
| 22-8 | 15,00 | 62 | 235 | 75 | 33 | 43 | 9,00 |
| 26-8 | 21,20 | 63 | 272 | 82 | 37 | 61 | 13,70 |
| 32-8 | 31,50 | 87 | 350 | 103 | 39 | 65 | 19,30 |

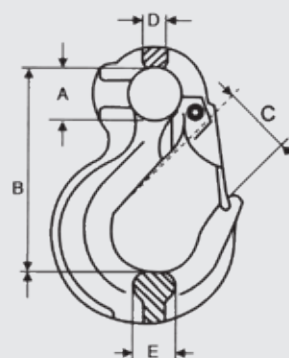

GANCHO CON PESTILLO CONEXIÓN DIRECTA G.80

| MEDIDA (MM.) | C.M.T. TON. | PRINCIPALES DIMENSIONES EN (MM.) | | | | | PESO NETO (KGS.) |
|--------------|-------------|----------------------------------|-----|----|----|----|------------------|
| | | A | B | C | D | E | |
| 6-8 | 1,12 | 8 | 75 | 24 | 14 | 22 | 0,30 |
| 8-8 | 2,00 | 9 | 85 | 24 | 17 | 27 | 0,50 |
| 10-8 | 3,15 | 13 | 103 | 29 | 23 | 32 | 1,00 |
| 13-8 | 5,30 | 16 | 126 | 36 | 27 | 45 | 1,80 |
| 16-8 | 8,00 | 21 | 144 | 46 | 35 | 60 | 3,50 |
| 20-8 | 12,50 | 24 | 176 | 53 | 51 | 62 | 6,60 |

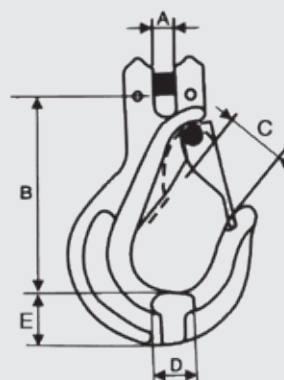

GANCHO DE SEGURIDAD G.80

| MEDIDA (MM.) | C.M.T. TON. | PRINCIPALES DIMENSIONES EN (MM.) | | | | | PESO NETO (KGS.) |
|--------------|-------------|----------------------------------|-----|-----|-----|-----|------------------|
| | | A | B | C | D | E | |
| 6-8 | 1,12 | 22 | 108 | 27 | 70 | 43 | 0,50 |
| 8-8 | 2,00 | 25 | 132 | 37 | 89 | 49 | 0,80 |
| 10-8 | 3,15 | 32 | 164 | 44 | 108 | 62 | 1,40 |
| 13-8 | 5,30 | 40 | 203 | 52 | 137 | 80 | 2,90 |
| 16-8 | 8,00 | 56 | 251 | 62 | 170 | 98 | 5,70 |
| 20-8 | 12,50 | 62 | 260 | 86 | 185 | 118 | 7,60 |
| 22-8 | 15,00 | 70 | 312 | 80 | 207 | 128 | 11,00 |
| 26-8 | 21,20 | 79 | 355 | 100 | 243 | 147 | 16,70 |
| 32-8 | 31,50 | 102 | 465 | 143 | 337 | 195 | 42,00 |

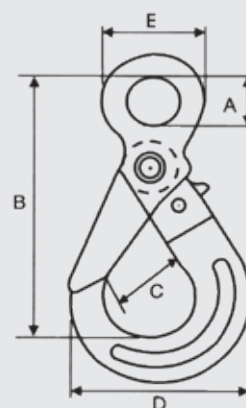

GRADO 80

ACCESORIOS

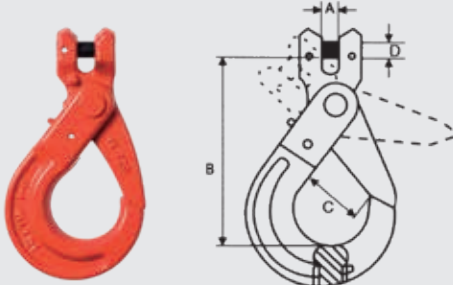

| GANCHO DE SEGURIDAD CONEXIÓN DIRECTA G.80 | | | | | | |
|---|-------------|----------------------------------|-----|----|----|------------------|
| MEDIDA (MM.) | C.M.T. TON. | PRINCIPALES DIMENSIONES EN (MM.) | | | | PESO NETO (KGS.) |
| | | A | B | C | D | |
| 6-8 | 1,12 | 9 | 94 | 27 | 8 | 0,50 |
| 8-8 | 2,00 | 9 | 108 | 37 | 9 | 0,80 |
| 10-8 | 3,15 | 13 | 145 | 44 | 13 | 1,50 |
| 13-8 | 5,30 | 15 | 175 | 52 | 16 | 3,10 |
| 16-8 | 8,00 | 18 | 210 | 62 | 20 | 6,10 |
| 20-8 | 12,50 | 25 | 230 | 86 | 25 | 7,90 |
| 22-8 | 15,00 | 25 | 270 | 80 | 29 | 11,30 |

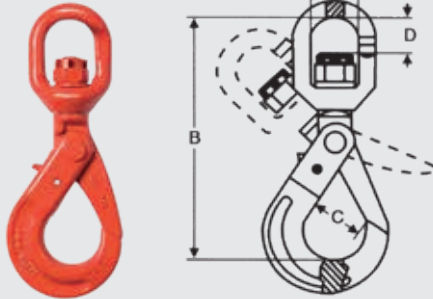

| GANCHO DE SEGURIDAD GIRATORIO G.80 | | | | | | |
|------------------------------------|-------------|----------------------------------|-----|-----|-----|------------------|
| MEDIDA (MM.) | C.M.T. TON. | PRINCIPALES DIMENSIONES EN (MM.) | | | | PESO NETO (KGS.) |
| | | A | B | C | D | |
| 6-8 | 1,12 | 33 | 152 | 27 | 25 | 0,70 |
| 8-8 | 2,00 | 35 | 183 | 37 | 27 | 1,10 |
| 10-8 | 3,15 | 42 | 217 | 44 | 36 | 2,00 |
| 13-8 | 5,30 | 49 | 260 | 52 | 40 | 3,70 |
| 16-8 | 8,00 | 60 | 325 | 62 | 53 | 7,10 |
| 20-8 | 12,50 | 72 | 352 | 86 | 58 | 9,80 |
| 22-8 | 15,00 | 96 | 455 | 80 | 93 | 17,20 |
| 26-8 | 21,20 | 121 | 525 | 100 | 113 | 29,80 |

Advertencia: Sólo girar el gancho sin carga.

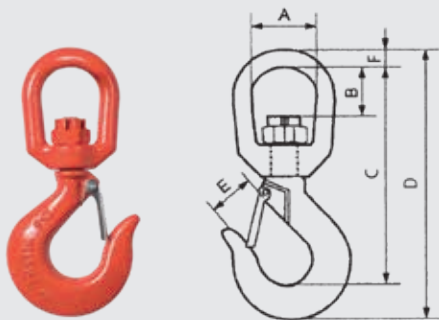

| GANCHO CON PESTILLO GIRATORIO G.80 | | | | | | | | |
|------------------------------------|-------------|----------------------------------|----|-----|-----|----|----|------------------|
| MEDIDA (MM.) | C.M.T. TON. | PRINCIPALES DIMENSIONES EN (MM.) | | | | | | PESO NETO (KGS.) |
| | | A | B | C | D | E | F | |
| 6-8 | 1,12 | 32 | 26 | 112 | 140 | 22 | 9 | 0,40 |
| 8-8 | 2,00 | 44 | 37 | 150 | 190 | 25 | 15 | 1,00 |
| 10-8 | 3,15 | 44 | 37 | 160 | 206 | 28 | 15 | 1,20 |
| 13-8 | 5,30 | 50 | 43 | 187 | 242 | 35 | 18 | 1,90 |
| 16-8 | 8,00 | 64 | 56 | 242 | 310 | 43 | 25 | 4,00 |
| 20-8 | 12,50 | 70 | 53 | 274 | 360 | 52 | 28 | 7,60 |
| 22-8 | 15,00 | 79 | 64 | 327 | 431 | 59 | 29 | 12,50 |

Advertencia: Sólo girar el gancho sin carga.

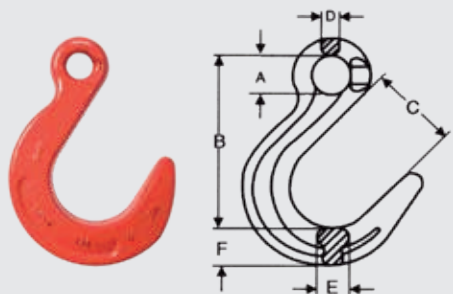

| GANCHO DE FUNDICIÓN G.80 | | | | | | | | |
|--------------------------|-------------|----------------------------------|-----|-----|----|----|----|------------------|
| MEDIDA (MM.) | C.M.T. TON. | PRINCIPALES DIMENSIONES EN (MM.) | | | | | | PESO NETO (KGS.) |
| | | A | B | C | D | E | F | |
| 6-8 | 1,12 | 18 | 118 | 62 | 12 | 24 | 31 | 1,00 |
| 8-8 | 2,00 | 18 | 118 | 62 | 12 | 24 | 31 | 1,00 |
| 10-8 | 3,15 | 22 | 146 | 75 | 17 | 33 | 38 | 2,00 |
| 13-8 | 5,30 | 27 | 173 | 87 | 19 | 38 | 44 | 3,10 |
| 16-8 | 8,00 | 32 | 198 | 98 | 19 | 45 | 53 | 5,10 |
| 20-8 | 12,50 | 37 | 230 | 111 | 26 | 57 | 65 | 9,10 |
| 22-8 | 15,00 | 44 | 258 | 124 | 29 | 60 | 68 | 11,70 |

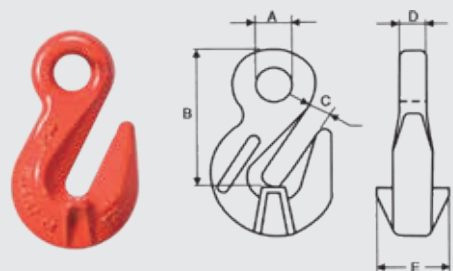

| GANCHO ACORTADOR G.80 | | | | | | | |
|-----------------------|-------------|----------------------------------|-----|----|----|-----|------------------|
| MEDIDA (MM.) | C.M.T. TON. | PRINCIPALES DIMENSIONES EN (MM.) | | | | | PESO NETO (KGS.) |
| | | A | B | C | D | E | |
| 6-8 | 1,12 | 14 | 45 | 8 | 9 | 22 | 0,10 |
| 8-8 | 2,00 | 16 | 59 | 10 | 9 | 30 | 0,20 |
| 10-8 | 3,15 | 20 | 79 | 13 | 14 | 46 | 0,60 |
| 13-8 | 5,30 | 26 | 99 | 16 | 16 | 57 | 1,30 |
| 16-8 | 8,00 | 30 | 102 | 19 | 19 | 71 | 2,00 |
| 20-8 | 12,50 | 36 | 130 | 22 | 22 | 93 | 4,80 |
| 22-8 | 15,00 | 44 | 160 | 27 | 28 | 90 | 7,40 |
| 26-8 | 21,20 | 44 | 184 | 28 | 35 | 100 | 10,00 |
| 32-8 | 31,50 | 55 | 230 | 37 | 42 | 113 | 18,00 |

GANCHO ACORTADOR CON PESTILLO CONEXIÓN DIRECTA G.80

| MEDIDA (MM.) | C.M.T. TON. | PRINCIPALES DIMENSIONES EN (MM.) | | | | | | | PESO NETO (KGS.) |
|--------------|-------------|----------------------------------|----|----|-------|----|-----|-----|------------------|
| | | A | B | C | D | E | F | G | |
| 6-8 | 1,12 | 8 | 32 | 8 | 26 | 6 | 43 | 75 | 0,20 |
| 8-8 | 2,00 | 9 | 35 | 11 | 33,50 | 11 | 50 | 89 | 0,33 |
| 10-8 | 3,15 | 12 | 45 | 13 | 46 | 12 | 70 | 126 | 0,88 |
| 13-8 | 5,30 | 15 | 53 | 16 | 57 | 13 | 96 | 163 | 1,85 |
| 16-8 | 8,00 | 18 | 69 | 19 | 72 | 17 | 112 | 183 | 3,24 |

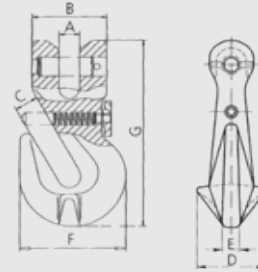
GANCHO ACORTADOR CAZOLETA G.80

| MEDIDA (MM.) | C.M.T. TON. | PRINCIPALES DIMENSIONES EN (MM.) | | | | | | PESO NETO (KGS.) |
|--------------|-------------|----------------------------------|----|----|----|-----|------|------------------|
| | | A-B | C | D | E | F | | |
| 6-8 | 1,12 | 7 | 8 | 7 | 14 | 45 | 0,30 | |
| 8-8 | 2,00 | 9 | 11 | 11 | 20 | 64 | 0,50 | |
| 10-8 | 3,15 | 12 | 13 | 13 | 22 | 87 | 1,00 | |
| 13-8 | 5,30 | 16 | 16 | 16 | 32 | 114 | 2,00 | |
| 16-8 | 8,00 | 20 | 20 | 21 | 38 | 135 | 3,50 | |
| 20-8 | 12,50 | 22 | 25 | 24 | 47 | 151 | 4,30 | |
| 22-8 | 15,00 | 24 | 28 | 27 | 57 | 185 | 7,80 | |

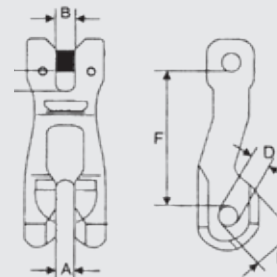
GANCHO CORREDIZO G.80

| MEDIDA (MM.) | C.M.T. TON. | PRINCIPALES DIMENSIONES EN (MM.) | | | PESO NETO (KGS.) |
|--------------|-------------|----------------------------------|-----|----|------------------|
| | | A | B | C | |
| 8-8 | 2,00 | 30 | 90 | 17 | 0,40 |
| 10-8 | 3,15 | 39 | 116 | 21 | 0,70 |
| 13-8 | 5,30 | 51 | 143 | 27 | 1,50 |
| 16-8 | 8,00 | 65 | 180 | 32 | 3,20 |

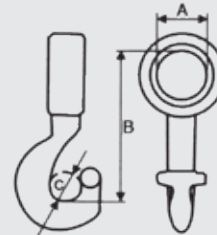
CONECTOR OMEGA G.80

| MEDIDA (MM.) | C.M.T. TON. | PRINCIPALES DIMENSIONES EN (MM.) | | | | PESO NETO (KGS.) |
|--------------|-------------|----------------------------------|----|----|----|------------------|
| | | A | B | C | D | |
| 8-8 | 2,00 | 22 | 34 | 10 | 11 | 0,20 |
| 10-8 | 3,15 | 31 | 40 | 12 | 16 | 0,30 |
| 13-8 | 5,30 | 40 | 54 | 16 | 20 | 0,70 |
| 16-8 | 8,00 | 48 | 61 | 18 | 26 | 1,10 |

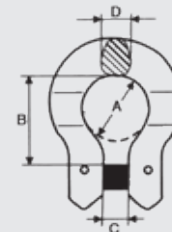
GANCHO PARA SER SOLDADO (EXCAVADORA) G.80

| MEDIDA (MM.) | C.M.T. TON. | PRINCIPALES DIMENSIONES EN (MM.) | | | | | | | PESO NETO (KGS.) |
|--------------|-------------|----------------------------------|-----|----|----|----|----|----|------------------|
| | | A | B | C | D | E | F | G | |
| GE-2 | 2,00 | 91 | 80 | 26 | 24 | 20 | 34 | 7 | 0,80 |
| GE-3 | 3,00 | 106 | 115 | 30 | 30 | 24 | 36 | 9 | 1,20 |
| GE-5 | 5,00 | 132 | 159 | 36 | 45 | 28 | 44 | 10 | 2,50 |
| GE-8 | 8,00 | 133 | 164 | 31 | 51 | 40 | 53 | 16 | 3,50 |
| GE-10 | 10,00 | 166 | 200 | 48 | 55 | 39 | 56 | 20 | 5,60 |

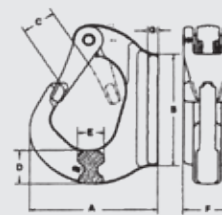
GANCHO S

| MEDIDA (MM.) | C.M.T. TON. | PRINCIPALES DIMENSIONES EN (MM.) | | | | PESO NETO (KGS.) |
|--------------|-------------|----------------------------------|-----|-----|-----|------------------|
| | | A | B | C | D | |
| S-10 | 0,15 | 10 | 115 | 28 | 28 | 0,15 |
| S-12 | 0,25 | 12 | 153 | 38 | 38 | 0,30 |
| S-14 | 0,35 | 14 | 190 | 50 | 50 | 0,50 |
| S-16 | 0,50 | 16 | 230 | 63 | 63 | 0,80 |
| S-20 | 0,75 | 20 | 267 | 76 | 76 | 1,50 |
| S-22 | 1,00 | 22 | 305 | 88 | 88 | 2,00 |
| S-26 | 1,30 | 26 | 331 | 100 | 100 | 3,20 |
| S-28 | 1,50 | 28 | 380 | 115 | 115 | 4,20 |
| S-32 | 2,00 | 32 | 407 | 127 | 127 | 6,00 |

