

BANDAS, JUNTAS Y GOMAS PARAGOLPES

Rubber bumper & strip finger protection / Caoutchouc de protection & pare-chocs

BANDA GOMA ANTIPINZAMIENTO

Rubber strip finger protection / Bande en caoutchouc pour la protection des doigts

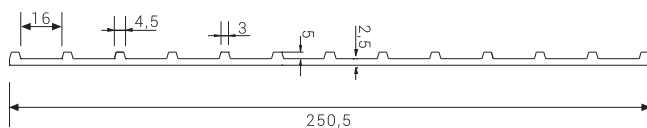
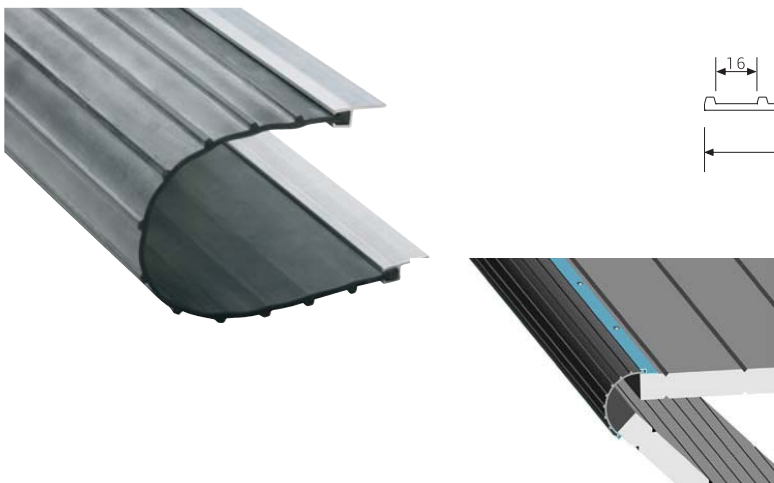

Ref.	Mt.	Mt.	PVP Mt.
800200	20 Mts.	0,876	11,7566€

BANDA GOMA ANTIPINZAMIENTO TIPO "FUELLE"

Rubber strip finger protection / Bande en caoutchouc pour la protection des doigts

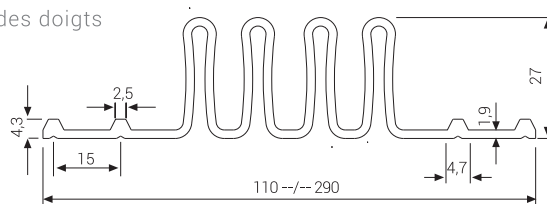

Ref.	Mt.	Mt.	PVP Mt.
800220	20 Mts.	0,773	9,3844€

BANDA GOMA TAPAJUNTAS

Rubber joint cover / Joints caoutchouc pour portes

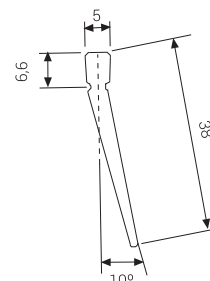
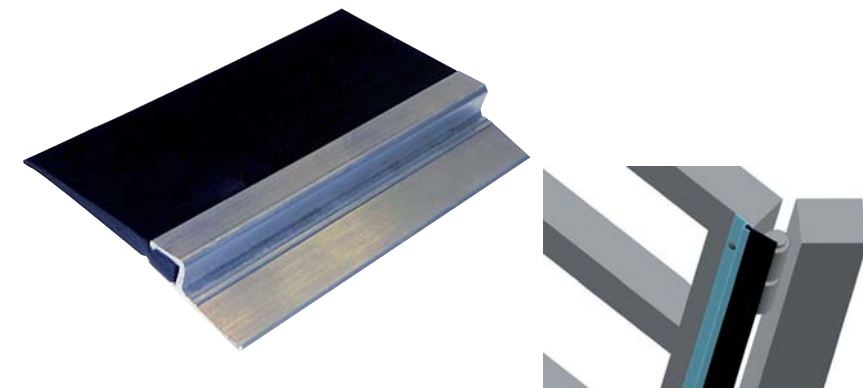

Ref.	Mt.	Mt.	PVP Mt.
800700	100 Mts.	0,152	2,8584€

BANDAS, JUNTAS Y GOMAS PARAGOLPES

Rubber bumper & strip finger protection / Caoutchouc de protection & pare-chocs

CEPILLO

Brush / Brosse

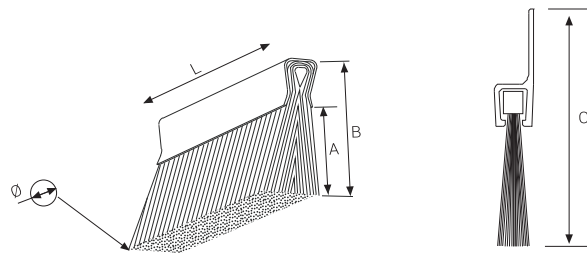

Ref.	Material	Ø	A	B	C	L			PVP
99957800	Nylon	0,15	25	30	50	3000	50	0,422	10,8174€
99957810	Polypropylene	0.20	45	50	70	3000	50	0,562	9,1135€
99957820	Polypropylene	0.30	62	67	87	3000	50	0,844	10,7975€
99958000	Cartón	-	-	-	-	3000	1	4,180	11,0892€

PERFIL ALUMINIO "h"

Aluminum profile "h" / Profil en aluminium "h"

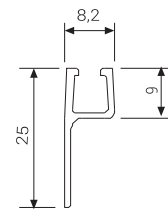

Ref.	L			PVP
99957900	3.000	100	0,364	6,6242€

PERFIL ALUMINIO "F"

Aluminum profile "F" / Profil en aluminium "F"

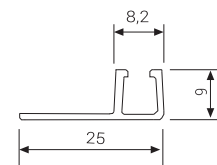

Ref.	L			PVP
99957910	3.000	100	0,361	9,9255€

BANDAS, JUNTAS Y GOMAS PARAGOLPES

Rubber bumper & strip finger protection / Caoutchouc de protection & pare-chocs

PERFIL ALUMINIO DE 25x14

Aluminum profile 25x14 / Profil en aluminium 25x14

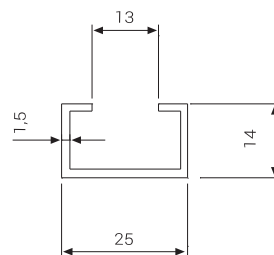

Ref.	L			PVP
99958900	2.000	100	0,427	7,6837€

GOMA 25x25 PARAGOLPES BASCULANTE

Rubber bumper 25x25 / Caoutchouc pare-chocs 25x25

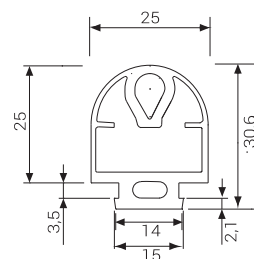
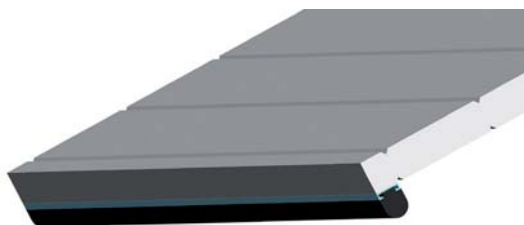

Ref.			Mt.	PVP Mt.
800300	20 Mts.	0,338		5,1599€

GOMA 25x40 PARAGOLPES BATIENTE

Rubber bumper 25x40 / Caoutchouc pare-chocs 25x40

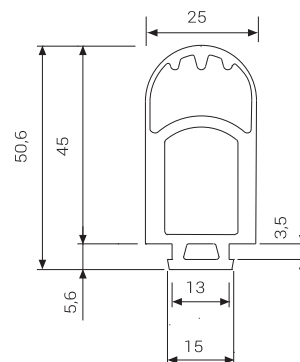
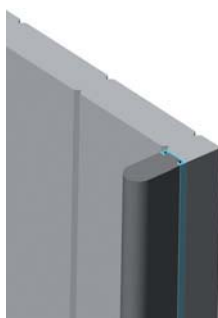

Ref.			Mt.	PVP Mt.
800600	25 Mttts.	0,666		48,7673€

BANDAS, JUNTAS Y GOMAS PARAGOLPES

Rubber bumper & strip finger protection / Caoutchouc de protection & pare-chocs

GOMA TAPA SEPARACIÓN ENTRE TUBOS

Caoutchouc couvre separation entre tubes / Seal rubber



Ref.	L			PVP
800900	6000	1	2,990	46,0404€

Montaje Puerta Batiente
Swing door assembly
Assemblage portail pivotant

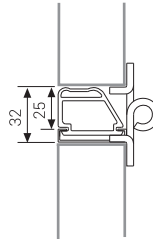
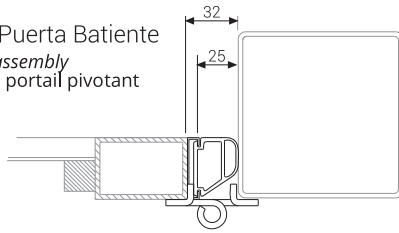

Montaje Puerta Basculante
Assembling over garage door
Montage des portes basculantes

PERFIL ACERO SOPORTE GOMA SEPARACIÓN TUBOS

Steel profile / Profile en acier

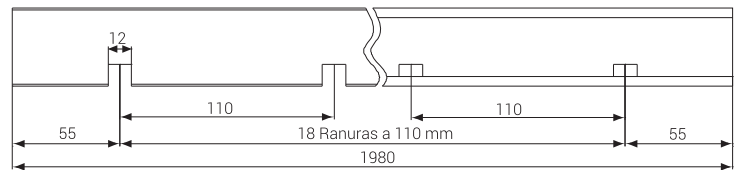
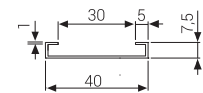

Ref.	L			PVP
99959900	1980	10	0,865	5,6874€

BISAGRA CON ALAS SEPARADORAS

Tilting door flat hinge to be welded with separating wings
Charnière universel de portail à souder avec des ailes d'écartement

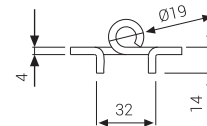
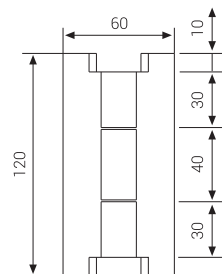

Ref.			PVP
200121000	12	0,361	2,3571€