

PB

ANTIPÁNICO PUSH-BAR

Antipánico reversible tipo PUSH. La reversibilidad de mano se realiza fácilmente en el momento de la instalación al disponer del "one second system". Apto de serie para puertas de hasta 2,66 m de altura. Permite instalar prolongadores para puertas de mayor altura (hasta 3 m). Certificado con marcación CE 1125. 3-7-7-B-1-4-2-2-B-A
Barras horizontales disponibles en longitudes de 840 y 1170 mm.

Materiales

- pestillo: acero
- capuchón: acero barnizado
- cárter: aluminio
- barra: aluminio

Acabados

- Negro / Negro
- Negro / Rojo
- Negro / Plata
- Efecto acero

Funcionamiento

- aplicación: apta su instalación interior/externo
- ciclos garantizados: 200.000
- accionamiento: 2 mm de presión de la barra

Certificado

CE EN1125  EN 1125: 2008 +/ EC1:2009
 3-7-7-B-1-4-2-2-B-A

Anclaje

- 1, 2 o 3 puntos

PB 1

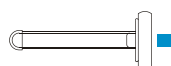

CE
EN 1125

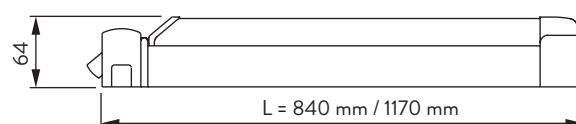
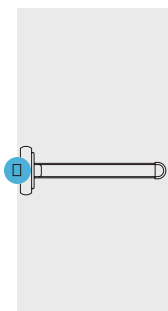

PB 2

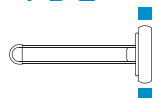

CE
EN 1125

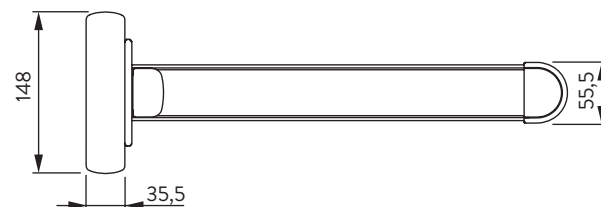
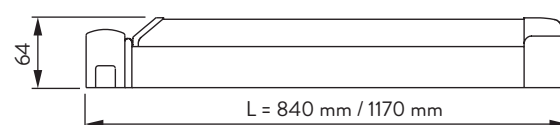
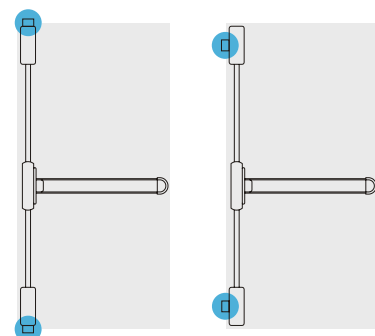

PB 3



CE
EN 1125

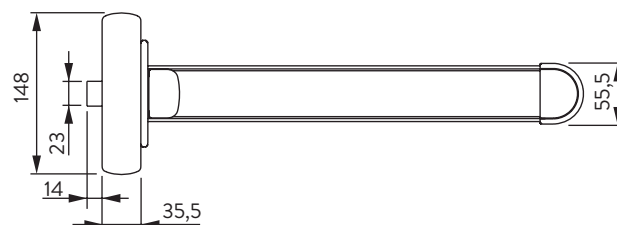
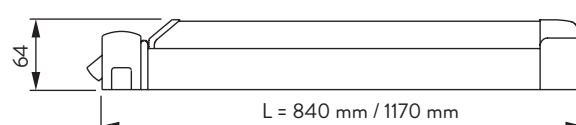
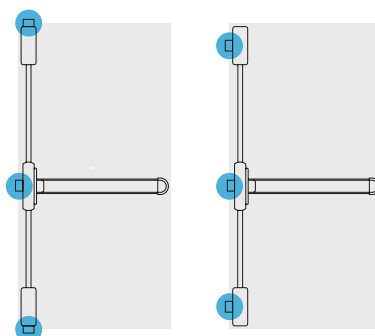

ACCESORIOS

GRUPO MANILLA Y CILINDRO

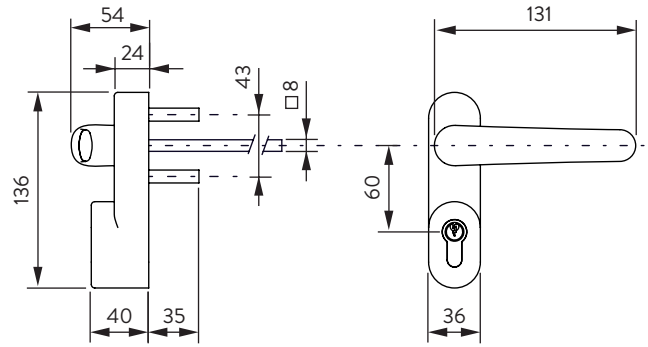
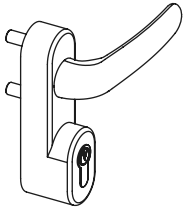

GRUPO POMO Y CILINDRO

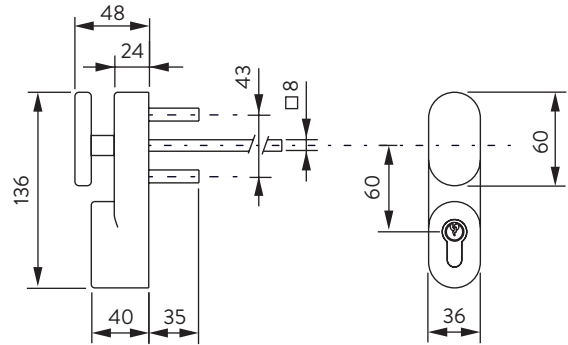
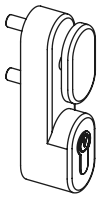

BARRAS VERTICALES (CON ASTAS Y PESTILLOS VERTICALES O LATERALES)

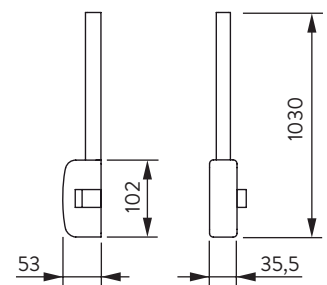
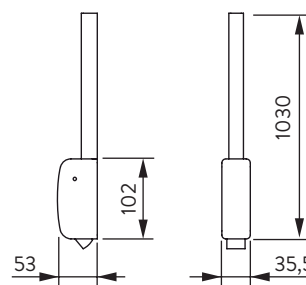
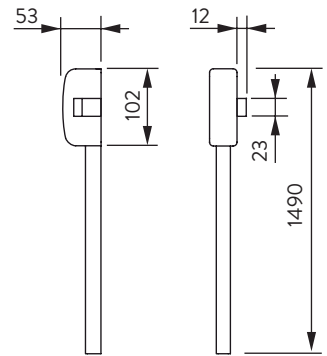
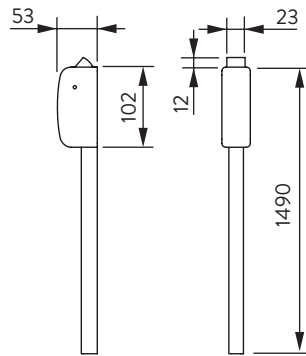
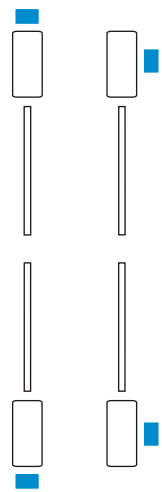

MANILLA EXTERNA EN ALUMINIO PINTADO

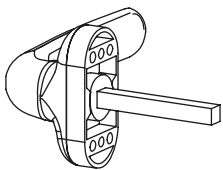

ACCIONAMIENTO CILINDRO EXTERIOR

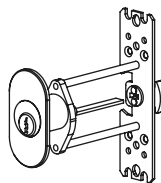

AP

ANTIPÁNICO REVERSIBLE MODULAR

Antipánico de sobreponer, reversible modular. El pestillo es siempre en acero inoxidable, lo que lo habilita para su instalación en puertas cortafuego (RF). Mecanismo de alta sensibilidad, a los 2 mm de presión ya actúa el pestillo. Apto de serie para puertas de hasta 2,66 m de altura. Permite instalar prolongadores para puertas de mayor altura (hasta 3 m). Certificado con marcación CE 1125. 3-7-7-B-1-4-2-2-A-A

Barras horizontales disponibles en longitudes de 950 mm, 1150 mm y 1450 mm.

Materiales

- pestillo: acero
- capuchón: acero barnizado
- cárter: aluminio
- barra: aluminio

Funcionamiento

- aplicación: apta su instalación interior/externo
- ciclos garantizados: 200.000
- accionamiento: 2mm de presión de la barra

Anclaje

- 1, 2 o 3 puntos

Acabados del cuerpo



Acabados de la barra



Certificado



EN 1125: 2008 +/ EC1:2009
3-7-7-B-1-4-2-2-A-A

AP 1

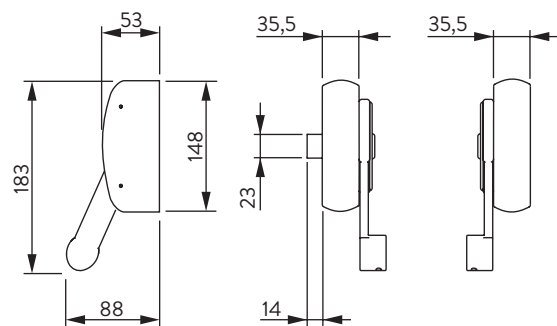
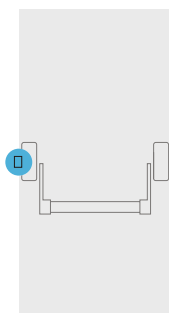
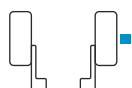

AP 2

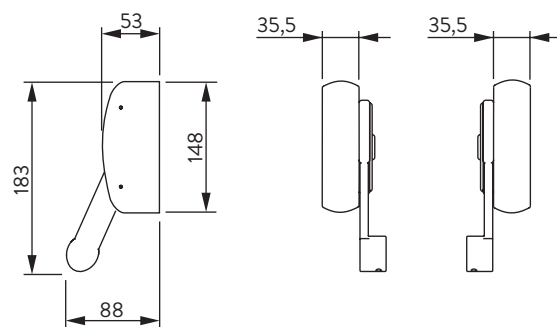
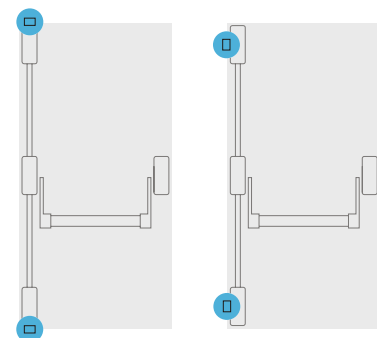

AP 3

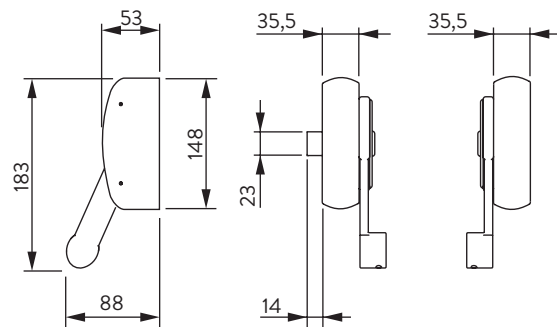
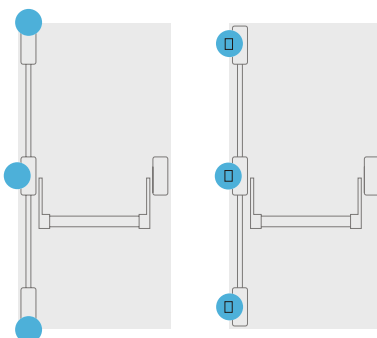

ACCESORIOS

GRUPO MANILLA Y CILINDRO

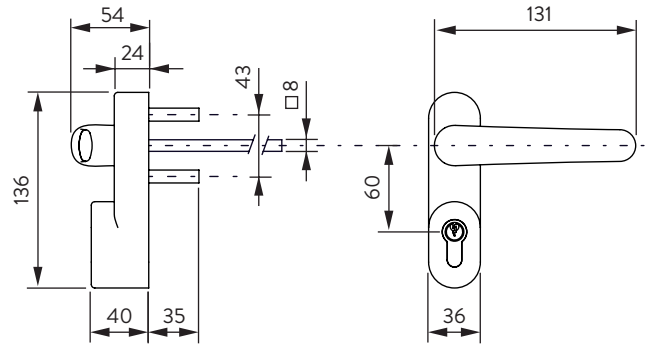
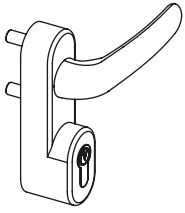

GRUPO POMO Y CILINDRO

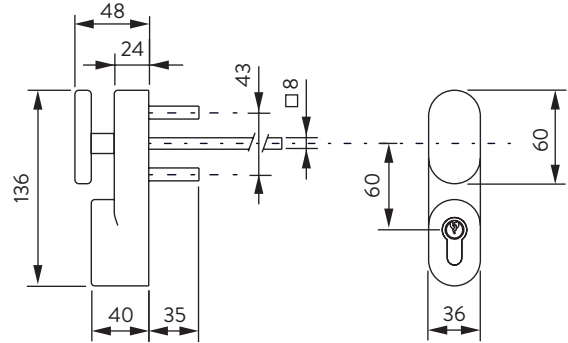
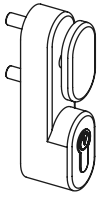

BARRAS VERTICALES (CON ASTAS Y PESTILLOS VERTICALES O LATERALES)

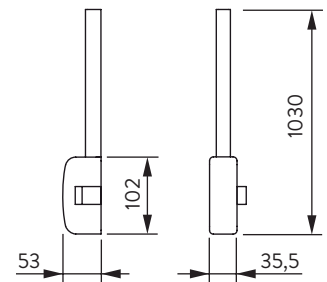
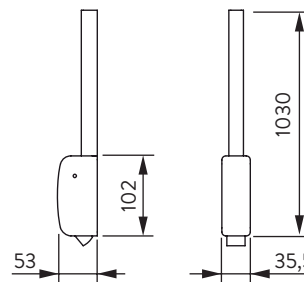
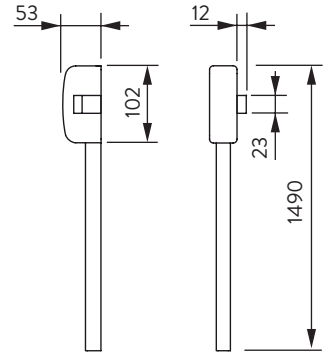
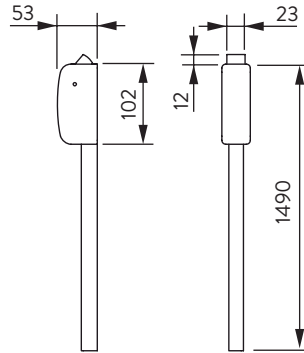
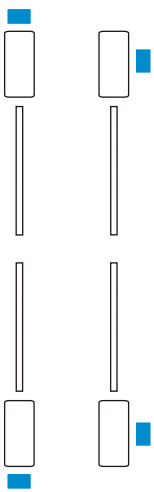

MANILLA EXTERNA EN ALUMINIO PINTADO

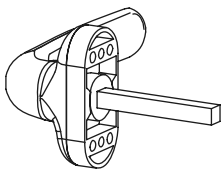

ACCIONAMIENTO CILINDRO EXTERIOR

